

Article number: 204080M1638A3X

Description: E+G levelling foot
GN 40-80-M16-38-A3-X

Note: X With female thread, External hexagon

Measures

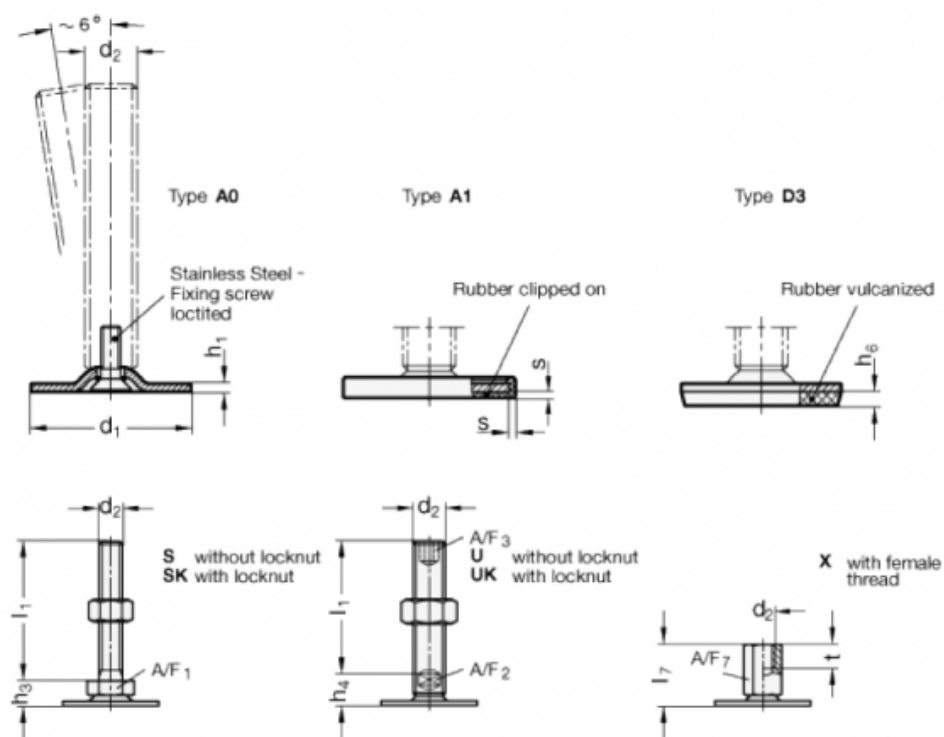

A/F7	= 22
d1	= 80
d2	= M16
h1	= 3
h6	= 5
l7	= 38
s	=
t	= 16